

SHOWDAILY™

The Daily News of IMTEX FORMING 2024

Organiser



Indian Machine Tool
Manufacturers' Association



International Forming Technology Exhibition

19 - 23 JANUARY 2024, BIEC, BENGALURU

Concurrent Shows



International Exhibition of Dies & Moulds, Forging Tools,
Machine Accessories, Technology and CAD / CAM



International Exhibition of
Digital Manufacturing Technology



Exhibition for Welding, Cutting & Joining | 2024

In association with

DAY 1 FRIDAY
19 JANUARY
2024

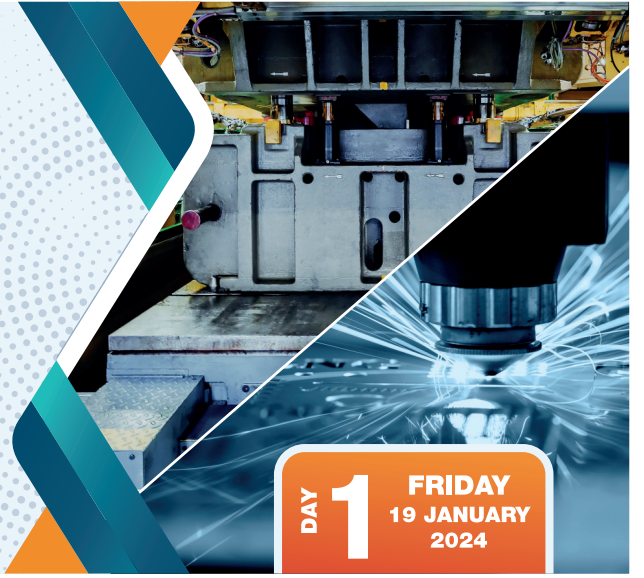

TruLaser Series 1000 Basic Edition

Economic reliable machine

TRUMPF



YOU ARE
INVITED!

19-23 January, 2024

Visit our booth B101,
Hall no.4, B.I.E.C.,
Bengaluru.

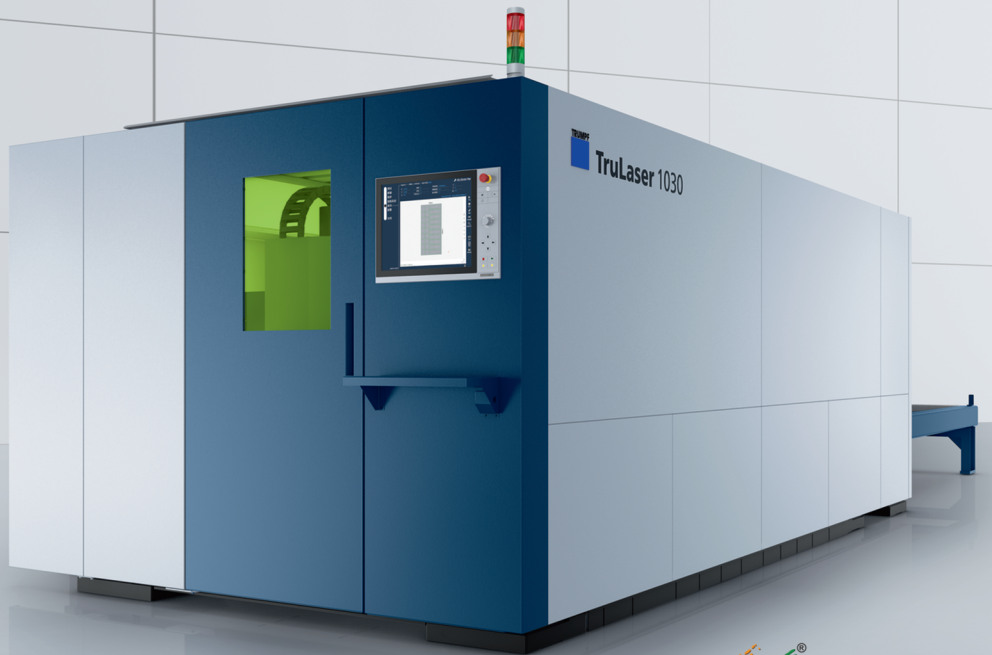

The TruLaser Series 1000 Basic Edition is the ideal start into the world of high-quality laser cutting. It is equipped with a TruFiber laser for cutting a wide range of sheet thicknesses. The intuitive programming system makes it possible to start production quickly. In addition, we are always on hand to lend our support: You can count on our experienced and competent service team to answer all your questions regarding maintenance and applications.



www.trumpf.info/r8y0lw

SCAN HERE

TRUMPF (India) Pvt. Ltd. Rasoni Industrial park, S. No. 276, Hissa No. 1, Village Mann, Taluka - Mulshi, Pune - 411057, Maharashtra, India. www.trumpf.com | Phone: +91 20-667-59800 | Marketing@in.trumpf.com

TruArc Weld



Easy to get into - automated welding

**YOU ARE
INVITED!**

19-23 January, 2024

Visit our booth B101,
Hall no.4, B.I.E.C.,
Bengaluru.



The welding cell is a fully equipped machine tool, tested by the Technical Supervisory Association (TÜV) and certified with CE. This includes an exhaust system, housing with anti-glare protection and safety equipment in line with TRUMPF standards. You can launch, program and operate the welding cell with very little training - video tutorials will do the job. You can utilize the welding cell in one- or two-station operation, depending on the component and lot size.



SCAN HERE

<https://bit.ly/478IMq6>

TRUMPF (India) Pvt. Ltd. Rasoni Industrial park, S. No. 276, Hissa No. 1, Village Mann, Taluka - Mulshi, Pune - 411057, Maharashtra, India. www.trumpf.com | Phone: +91 20-667-59800 | Marketing@in.trumpf.com

SHOWDAILY™

The Daily News of IMTEX FORMING 2024

Organiser



Indian Machine Tool
Manufacturers' Association



International Forming Technology Exhibition

19 - 23 JANUARY 2024, BIEC, BENGALURU

Concurrent Shows



International Exhibition of Dies & Moulds, Forming Tools,
Machine Accessories, Technology and CAD / CAM



International Exhibition of
Digital Manufacturing Technology



Exhibition for Welding, Cutting & Joining | 2024

In association with

DAY
1

FRIDAY
19 JANUARY
2024

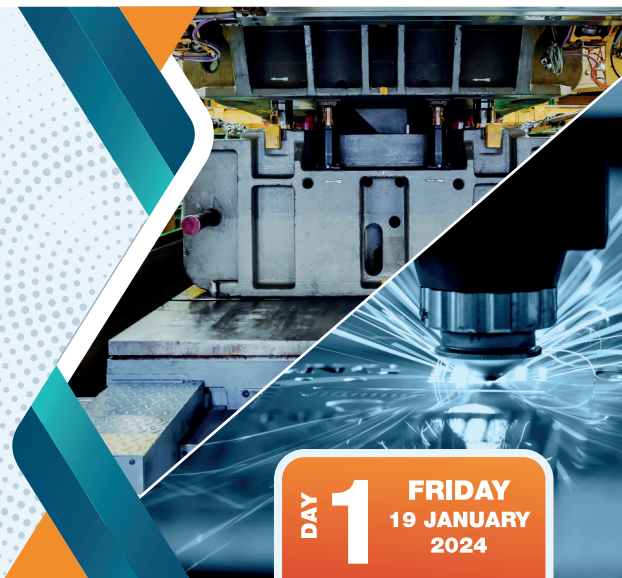

TOWARD SUCCESS

IMTEX FORMING 2024: Focused on Continual Growth

With all the developments that put us as a nation in a highly coveted position, IMTEX FORMING 2024 & Tooltech 2024 stands as a crucial platform to showcase our strengths in manufacturing for the Indian machine tools sector to grow and contribute to our holistic progress. Starting from today, the expo will run until January 23, 2024, at Bangalore International Exhibition Centre (BIEC).

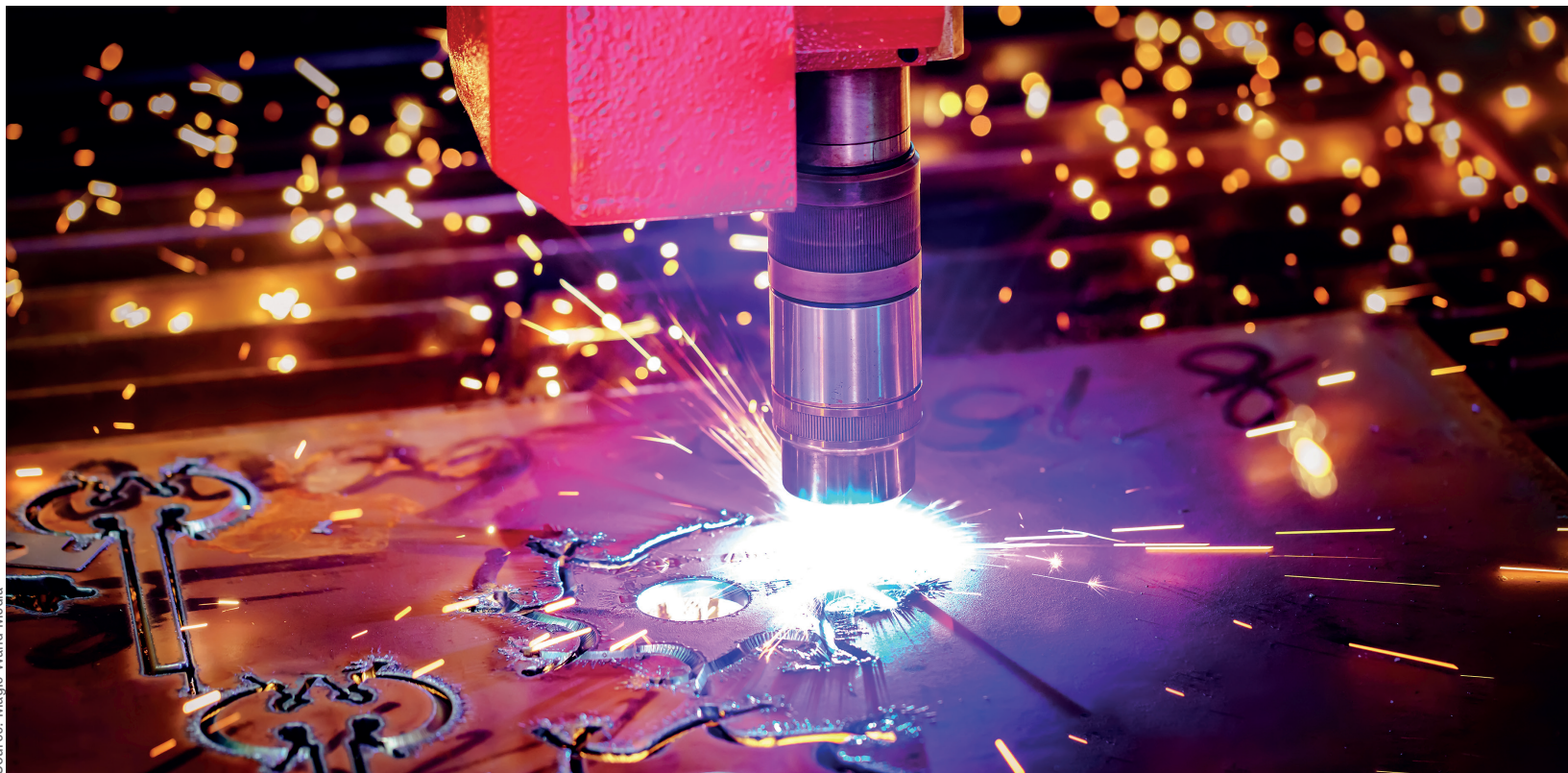

Source: Magic Wand Media

As India progresses toward becoming a global manufacturing powerhouse, IMTEX FORMING 2024 & Tooltech 2024, Asia's largest exhibition on metal forming technologies, organized by Indian Machine Tools Manufacturers' Association (IMTMA), is perfectly poised to offer industry players a glimpse into the future of manufacturing technology and foster collaborations for sustained growth.

Growth in the machine tool sector

The Indian Machine Tool industry, as part of the Capital Goods sector,

has performed well in 2023 and is looking forward to improving its position in 2024 and beyond. Consumption of machine tools in India during FY 2022-23 increased by 55 percent, reaching about ₹24,500 crore (around US \$3 billion). Among metal working machine tools, the country's Metal Forming sector, with a market size of around ₹5,300 crore (about US \$646 million) in FY 2022-23, has been doing well with new trends entering the market. Compared to the previous year, metal forming production, which was around ₹2,100 crore (about US \$256 million) in FY 2022-23, is expected to grow at a

compound annual growth rate of around 10-15 percent in the next 3-5 years.

IMTEX FORMING 2024 at an opportune time

Highlighting the show's significance, Rajendra S Rajamane, President, IMTMA, emphasizes, "IMTEX FORMING attracts the entire metal forming machine tool fraternity from India and other parts of the world to offer various solutions to the huge domestic market in India and help them advance in their manufacturing activities." "Near net shape manufacturing is gaining prominence. Electric vehi-

cles are increasingly being considered as a viable alternative, and metal forming and welding manufacturers are seeing a better growth curve. Also, the incremental spending on the manufacture of new railway coaches is providing new avenues for sheet metal business. Furthermore, laser-cutting machines are gaining popularity across industry segments with laser-based solutions increasing by over 50 percent in comparison to its previous editions," he points out. To this adds, Jibak Dasgupta, Director General & CEO, IMTMA & BIEC, "IMTEX FORMING 2024 promises to be bigger and better.

To be continued on 4 ▶

RAJENDRA S RAJAMANE
President
Indian Machine Tools
Manufacturers' Association
(IMTMA)

IMTEX FORMING attracts the entire metal forming machine tool fraternity from India and other parts of the world to offer various solutions to the huge domestic market in India and help them advance in their manufacturing activities.



JIBAK DASGUPTA
Director General & CEO,
IMTMA
Bangalore International
Exhibition Centre (BIEC)

MSMEs have a significant presence in India's manufacturing industry landscape, and IMTMA has always supported Indian manufacturing and machine tool MSMEs by providing them an opportunity at the IMTEX platform and other exhibitions nationally and internationally.



It has grown by around 80 percent in size compared to its previous edition. It has many new segments to showcase for its visitors."

Highlights of the show

The exhibition features over 625 exhibitors from 20 countries in an exhibition space of around 45,000 sq mt, covering 5 exhibition halls. Around 1,000 trade delegation members and 40,000 visitors are expected to attend IMTEX FORMING 2024. Germany, Japan, and Taiwan have country pavilions. The exhibition portfolio has enlarged with the entry of Weldexpo,

an exhibition for welding, cutting, and joining in association with the Indian Institute of Welding (IIW) as a concurrent show, alongside Tooltech and Digital Manufacturing. IIW is organizing an International Congress from January 22-24, 2024, at BIEC.

Additionally, MOLDEX India and FASTNEX, organized by Messe Stuttgart India, focusing on molding, fasteners, and fixing technologies respectively, are co-located shows.

i2 Academia Square comprises three initiatives, viz., Academia Pavilion, CONNECT, and Manufac-

turing Quiz Contest. Around 25 institutions including IITs are participating in the event. The Manufacturing Technology Quiz Contest will be held as an inter-college contest on manufacturing technology for engineering students.

While CONNECT aims to augment the career of technical students in machine tool and manufacturing industries, the Jagruti-IMTMA Youth Programme, with the aid of UDAAN members, will be held to familiarize engineering students with the Machine Tool industry.

Also, an International Seminar on Forming Technology to highlight

advancements in metal forming technologies was held yesterday. Introductory sessions on Industry 4.0 will be held in the Productivity Institute of IMTMA Technology Centre, during the show.

IMTEX FORMING has gained a reputation not just as a mere trade fair; it is the catalyst for transformative advancements in metal forming technologies. With its pulse on innovation, this edition of the event too is poised to garner significant industry response and lead the industry toward excellence and progress.

SD

IMTEX FORMING 2024
Hall: 3A
Stall: C116

SOLUTIONS FOR ELECTRIC VEHICLES

Chennai Metco
www.chennaimetco.com

AWARD WINNING TECHNOLOGY

Ground Breaking Applications for Laser Processing



High-speed, Stable-processing fiber laser machine

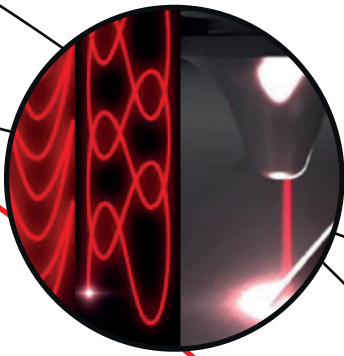

Revolutionary beam control
Beam pattern manipulation
& Kerf width control

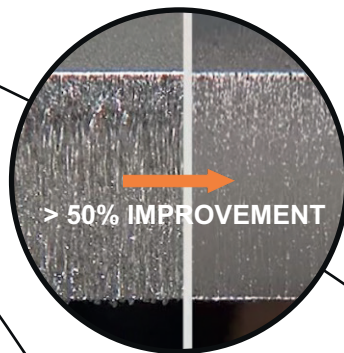

Co2 type quality
50% cut surface improvement
vs conventional solid state lasers

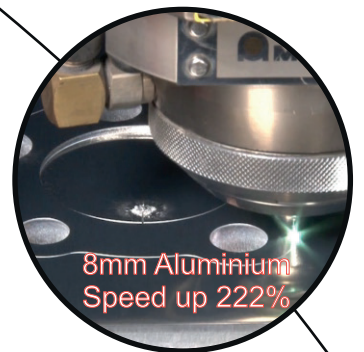
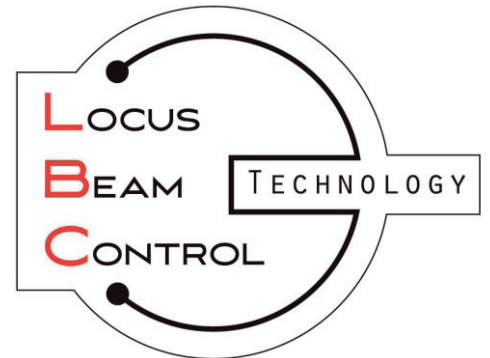

Lower cost-per-part
Higher productivity with
less power and lower investment

AMNC 4ie



VENTIS AJe
Fiber Laser



Hall No - 5
Booth No - B105



Amada (India) Pvt. Ltd
Technical and Vocational Center
No.60, KIADB Bengaluru Aerospace Park,
Singahalli Village, Budigere Post, Bangalore,
North Taluk - 562129, India.
Ph:080-71100200



AMPCO METAL INDIA'S GROWTH JOURNEY

From Global Expertise to Local Excellence

Since 1914, AMPCO METAL has partnered with industry leaders to develop solutions for diverse applications requiring exceptional material properties like friction and wear resistance, corrosion resistance, and heat and electrical conductivity. In 2012, AMPCO METAL INDIA Pvt Ltd, a wholly-owned subsidiary of

AMPCO METAL SA, established its base in Pune, Maharashtra. Today, the company caters to niche applications in the Indian market, particularly in the forming industry. Its expertise lies in providing solutions for tube bending, tube forming rolls/welding shoes, and deep drawing dies/end forming punches and materials for the plastic mold-making industry.

AMPCO METAL INDIA Pvt Ltd is an ISO 9001:2015 certified company with a dedicated warehouse and service center in Chakan, Pune. This facility ensures an efficient stock of materials of various grades in various shapes and sizes and is equipped with sophisticated machines for precision component manufacturing, readily available to meet customer requirements.

The company proudly highlights its state-of-the-art facility in Pune. Equipped with a comprehensive array of advanced machinery, including CNC turning centers, vertical machining centers, turn-mill machines, wire-cutting machine, and a heat treatment facility, the facility has the flexibility to tackle a diverse range of project requirements and customers' critical timelines. It also employs sophisticated inspection equipment, including CMM (Coordinate Measuring Machine), to ensure that every component it produces meets its high-quality standards. This meticulous attention to detail guarantees that its customers receive nothing less than the best. With cutting-edge facilities and an unwavering commitment to quality, AMPCO METAL is a leading force in the Indian forming industry. Its unwavering dedication to customer satisfaction ensures that every project receives the highest precision and expertise, solidifying its position at the forefront of the industry. **SD**



AMPCO METAL INDIA Pvt Ltd
www.ampcometal.com
Hall & Stall: 3A/A-126

Source: AMPCO METAL

i2 Academia Square

19 - 23 January 2024

Venue: i2 Academia Square HALL 4, BIEC

LEARN · EXPLORE
CONNECT & GROW

An initiative of IMTMA to strengthen the industry-academia interface, foster innovation, nurture talent and drive technological advancements in the manufacturing industry.

i2 Academia Square Features

Academia Pavilion

Academia Pavilion : 19 - 23 January 2024

Meet 25 premier academic institutions showcasing their R&D in metal forming and allied technologies.

Manufacturing Technology Quiz : 20 January 2024

Participate in an inter-college contest on manufacturing technology for mechanical engineering students to showcase their skills in a competitive spirit.

Connect : 21 January 2024

CONNECT

A forum to meet and hire young engineers

CONNECT on as one of the added attractions wherein engineering students from mechanical and electrical streams, among others can meet, network, and explore opportunities in various machine tool and manufacturing companies. Interact with budding engineers seeking to augment their careers in manufacturing industries.

Visit i2 Academia Square to interact with young engineers and academicians to experience the refreshing curiosity and innovation....

PUNCHING MACHINES

Euromac Punching Machines

Euromac Punching Machines are dynamic and flexible and are ideal for superior manufacturing. They are versatile and high-performance solutions while being economical and user-friendly. In the company's patented hybrid technology, the hydraulic ram is controlled by a feedback control servomotor for greater power delivery at an increased accuracy and precision in repeatability. The machines are equipped with flexible turret configurations so that one is not restricted to manufacturers' standard turret station sizes. Tool configurations with up to 102 tools capacity with rotation of up to 48 tools are possible. Euromac XT Machines are equipped with 6 B stations with retractable dies, which makes them ideal for scratch-free sheet processing during forming operations. Their patented multi-tool technology can accommodate

multiple A, B, or C station tools inside a single station, making them compact and reducing the tool changing time. The average power consumption is the industry's best 4.5 KW which brings down the running cost to a bare minimum. The Euromac Direct Drive system for tool rotation eliminates transmission components, featuring more precision, strength, and less wear. A robust casted C-frame is used in building the machinery. The open design of the frame makes it possible to process the sheet sizes twice the size of its throat depth. The machines have high processing speeds of up to 1,080 hits/min in nibbling and 2,000 hits/min in marking. Die clearances down to 0.10 mm allows one to punch extremely thin materials (0.6) including all auto indexed tool. A clamp opening capacity of 11 mm allows one to punch/process high-thickness soft metal like bus bars etc. **SD**

Source: RadCAM Technologies Pvt Ltd

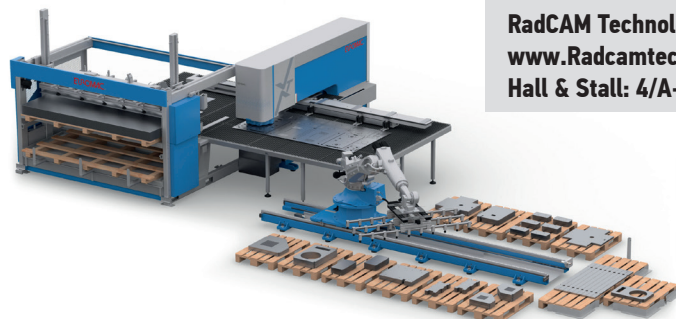

RadCAM Technologies Pvt Ltd
www.Radcamtechnologies.com
Hall & Stall: 4/A-107

Our state of the art facility in Pune, Chakan MIDC, India



AMPCO[®] 18, 21 & M4

Expert materials for tube bending

- Maximize tools speed
- Improve sliding properties
- Increase product quality
- No seizing or scratching
- Reduce production cost
- Minimum friction

Tube Bending



Tube Forming



Deep Drawing



AMPCO[®] 25

Expert material for tube forming and deep drawing

- Excellent sliding properties
- High hardness, extended life time
- No cold welds, no galling
- Perfect score free surface on stainless steel.
- Not hardening or expensive coating needed
- Easy to regrind, high thermal conductivity

Applications



Plastic Industry

AMPCOLOY[®] 83/944/940/95



Soap Mould

AMPCOLOY[®] 940/944



Resistance Welding

AMPCOLOY[®] 972/940/83/95



Aerospace & Offshore

AMPCO[®] 45/M4
AMSA4640/4881

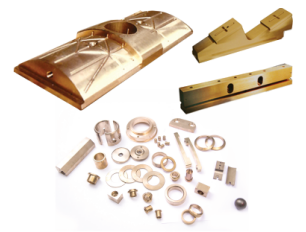

Steel Mill &
General Engineering
AMPCO[®] 18/21/M4

Address

AMPCO METAL INDIA PVT. LTD.

A-8/4, At Village - Nighoje, Chakan MIDC,
Phase IV, Tal : Khed, Pune – 410501
MAHARASHTRA, INDIA
Tel: +91 2135 610 810 | Fax: +91 2135 610 811
infoindia@ampcometal.com

AMPCO METAL S.A

Route de Chesalles 48 P.O Box 45,
1723 Marly Switzerland
Toll Free Phone: 800 8080 5050
Tel.: +41 26 439 93 00
Fax.: +41 26 439 93 01

Food Approval of AMPCO[®], AMPCOLOY[®] Materials
AMPCO[®] 18, AMPCO[®] M4, AMPCOLOY[®] 940, AMPCOLOY[®] 944



INDUSTRY - ACADEMIA PARTNERSHIP

i2 Academia Square: Bridging Industry & Academia

The i2 Academia Square, a flagship initiative of the Indian Machine Tool Manufacturers' Association (IMTMA), is poised to facilitate a dynamic convergence between industries and academia, fostering transformative technologies.

Recognizing the pivotal role of collaboration in driving innovation, technological advancements, talent nurturing, and overall economic growth, i2 Academic Square emerges as a benchmark initiative for more comprehensive engagements between industry and academia. In addition to fostering partnerships that benefit both academia and industry, and streamlining activities to prepare an industry-ready workforce, reduce

on-the-job training costs, and enhance student employability, the event's key features include:

Academia Pavilion:

From January 19-23, this pavilion houses 25 academic and research institutions. It provides an excellent opportunity for industry professionals in technology, design, production, etc., to interact with academic and R&D institutions, showcasing their projects and R&D capabilities in the domain of Metal forming and allied technologies.

Manufacturing Technology Quiz:

On January 20, there will be an Inter-Collegiate Quiz Contest on

manufacturing technology for mechanical engineering students. Winners will be given a certificate and a cash prize.

CONNECT Forum:

On January 21, this forum offers IMTMA's member companies a platform to meet and recruit young engineers. It is an excellent opportunity for budding engineers to demonstrate their capabilities and competitiveness among industry professionals. With a comprehensive list of participating institutions and projects on display, i2 Academia Square promises an enriching experience, fostering collaboration for transformative advancements in technology and education. **SD**

TRUMPF



Watch this space for Latest Announcement!



TRUMPF (India) Pvt Ltd
www.trumpf.com
Hall & Stall: 4/B-101

i2 ACADEMIA SQUARE EVENTS

- Academia Pavilion: Jan 19-23, 2024, i2 Academia Square, HALL 4, BIEC
- Manufacturing Technology Quiz: Jan 20, 2024, i2 Academia Square, HALL 4, BIEC
- CONNECT Forum: Jan 21, 2024, i2 Academia Square, HALL 4, BIEC

Largest Machine Tool and Manufacturing Technology Show in South and South-East Asia



International Machine Tool & Manufacturing Technology Exhibition

Concurrent shows



23 - 29 January 2025, Bengaluru

Organiser



Venue



EUROMAC®

Master of All,
Second to None!!!



Turret Punching Machine

- 1) Industry Best Power Consumption of 4.5 KW.
- 2) Capacity of 102 tools with 48 indexed tools.
- 3) Available in Hydraulic, Hybrid, Electric.
- 4) Can Process 3000 x 1500 without reposition.
- 5) Scratch free sheet processing.
- 6) Can Punch upto 6mm MS. and 10mm Copper



VISIT US AT

HALL 4,

19 - 23 January 2024, STALL A107
BIEC - Bengaluru

 **Radcam**
Technologies
Solutions Simplified

Mail: info@radcamtechnologies.com

JAPAN MACHINE TOOL BUILDERS' ASSOCIATION

United We Stand and Grow

Association of metal cutting machine tool builders from Japan, Japan Machine Tool Builders' Association (JMTBA) is a regular participant in IMTEX exhibitions. This edition too, the association is here in the Japan Pavilion and is looking forward to fruitful encounters, shares Kazuo Yuhara, President, JMTBA.

Strengthening the India-Japan bond

Yuhara acknowledges the fact that India is poised to develop as a manufacturing hub for the world. Indian Government's 'Make in India' manufacturing promotion policy has significantly boosted this development, he adds. "High-quality capital investment is expected, including high-precision, high-productivity machine tools. At this IMTEX FORMING many types of equipment and machinery that can contribute to the growth of the Indian manufacturing industry are being exhibited, and, we believe

this will greatly contribute to uncovering latent demand for equipment," he remarks.

"We expect to meet professional buyers with roots in the Indian market. Collaboration with them can help us advance our presence in the Indian market," he adds. Several JMTBA member companies are also exhibiting at IMTEX FORMING. Yuhara apprises us on the tune of exports having taken place from Japan to India in 2022-2023 in the machine tool sector, "Looking at export trends from Japan, the value of exports in 2022 was 36 billion yen, an increase of 27.6 percent compared to the previous year, an increase of just under 30 percent. Similarly, statistical figures for 2023 cannot be compared as they have not been made public yet, but looking at the trade statistics up to October, the cumulative total was 32 billion yen, a decrease of about 10 percent from the previous year to 89.2 percent."

When asked which new manufacturing technologies and practices

**KAZUO YUHARA
PRESIDENT
JAPAN MACHINE TOOL
BUILDERS' ASSOCIATION**

The value of exports from Japan to India in 2022 was 36 billion yen, an increase of 27.6 percent compared to the previous year, an increase of just under 30 percent. Looking at the trade statistics up to October 2024, the cumulative total was 32 billion yen, a decrease of about 10 percent from the previous year to 89.2 percent.



Source: Japan Machine Tool Builders' Association

from Japan can help the Indian manufacturing sector upgrade its processes, Yuhara highlights

digital twin, automation technology, and environmentally friendly technologies. **SD**

Japan Machine Tool Builders' Association
www.jmtba.or.jp
Hall & Stall: 4/B163B

Would you like to be crowned a Productivity Champion ?
..... Share your success stories on **PRODUCTIVITY | TECHNOLOGY | INNOVATION....**

Win Cash Awards upto **₹10,00,000**

IMTMA - ACE MICROMATIC Productivity Championship Awards 2024
"Showcasing Excellence in Manufacturing"

@
National Productivity Summit 2024
November 2024

No Entry Fee | Multiple Entries Welcome !

Special streams

- Micro & Small Enterprises
- Automotive & Auto Component Industry
- Non-Automotive Industry

Rush your entries by 30 April 2024

Contact: **Abhishek** M: +91 9844294387 E: abhishek@imtma.in | **Madan** M: +91 7899437625 E: madan@imtma.in

For more details logon to: www.productivity.imtma.in

ORGANISED BY: **Indian Machine Tool Manufacturers' Association**

AWARDS SPONSOR: **AceMicromatic Group**

PLATE BENDING & SECTION BENDING MACHINES

Heavy-duty MCB for Wind Energy

MCB is a 4-roll machine equipped with dedicated solutions and accessories specifically designed for the manufacturing of wind energy towers and foundations. MCB machines are equipped with a range of accessories, including vertical and lateral positioning capabilities, which allow for precise and efficient manufacturing. These accessories ensure that the fabrication process is not only highly accurate but also adaptable to the unique requirements of each product. DAVI also has a set of different feeding systems that adapt to various necessities. The heart of the company's wind energy production process lies in its advanced CNC technology. Through CNC, DAVI can meticulously control and manage the entire manufacturing process. This results in superior reliability, unparalleled quality, optimized output performance, and substantial energy savings. The CNC systems are at the forefront of automation and precision, ensuring that every final product meets the highest industry standards.



Batliboi Ltd
www.batliboi.com
Hall & Stall 4/A-152

AUTOMATED TANDEM PRESS LINES

Automated Tandem Press Lines from ISGEC



Source: ISGEC Heavy Engineering Ltd

Automated Tandem Press Lines have become very popular with various Tier-1 Indian customers due to flexibility in the production of parts and high productivity. ISGEC has worked with various leading global robotic suppliers like ABB, KUKA, and YASKAWA and can offer a complete solution for these type of presses.

ISGEC Heavy Engineering Ltd
www.isgec.com
Hall & Stall: 2A/B-101



PRESSES

Mechanical • Hydraulic • Servo
INDIA

5500+ Presses
100+ Transfer Presses
90+ Press Lines
Across 26 Countries

International Quality • International Technology • International Footprint

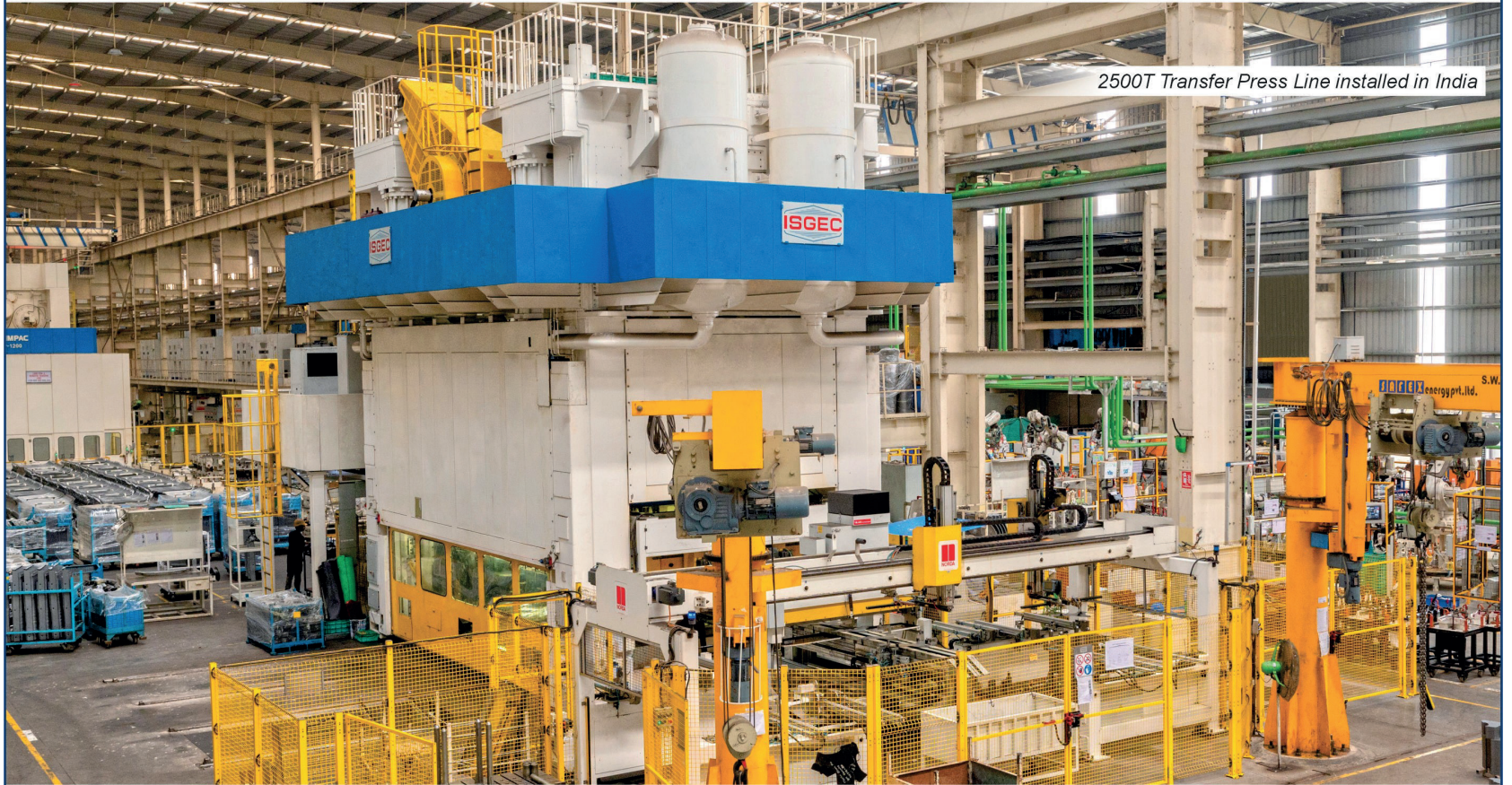

2500T Transfer Press Line installed in India

LINK DRIVE WITH CUSHION AT 1ST STATION / SERVO DRIVE OPTION
CUSTOMIZED LOAD BEARING CAPACITY ON DEMAND
MOVING BOLSTERS FOR FAST DIE CHANGE OVER



1500T Mechanical Tryout Press installed in India



4500T Robotic Tandem Press Line installed in Vietnam

Product Range: Transfer Presses • Tandem Lines • Progressive Presses • Standalone Presses • Servo Presses
Blanking Presses • Hydraulic Presses • Tryout & Die Spotting Presses • Gap Frame Presses • Hot Stamping Presses

Contact: Yogesh Saxena (+91-98965-49519) E-mail: presses@isgrec.com web: www.isgrec.com

Follow us on:

PRESS BUILDER TO THE WORLD

FIBER LASER MACHINES

VENTIS-AJe Series with LBC Technology

VENTIS stands for wind in Latin. VENTIS AJe is equipped with LBC technology. LBC is an abbreviation for Locus Beam Control and is the first technology in history that makes it possible to freely control the trajectory of a laser beam. A high-intensity single-module oscillator with unique beam control patterns, depending on the material and sheet thickness, helps to achieve higher speed and high-quality processing. Ventis AJe is available in 4/6kW power, boasting high torque motors and a helical drive system that achieves a rapid feed rate of 170m/min. The latest AMNC 4ie controller, developed with the four E's concept (Economy, Ecology, Ergonomics, and Expertise), addresses crucial sustainability, people, and environmental issues. This controller not only manages machines and peripheral devices but also provides support to customers. It allows the measurement of CO₂ emissions for each part, generating reports and output files. The machine employs face recognition to identify operators and enables real-time monitoring of the processing machine through a smartphone. Remote schedule editing and start/stop functionalities are also available. **SD**

Source: Amada (India) Pvt Ltd

Amada (India) Pvt Ltd
www.amadaindia.co.in
Hall & Stall: 5/B-105



LOADING ARMS

ROLLBLOC Loading Arms



Source: Gütthle Pressenspannen GmbH

Gütthle Pressenspannen GmbH
www.guetthle-swt.de
Hall & Stall: 4/B-125

Gütthle has designed these consoles to enhance the die-changing process. Cantilever consoles can handle heavy loads and act as an extended press table, which acts as a reliable transfer station for cranes or forklifts. Gütthle provides a complete range of features to improve the productivity and safety of operators.

Features of the product are:
Transfer Station for Cranes or Forklifts: These Loading Arms provide a stable platform for the lifting and movement of heavy dies/press tools using overhead cranes or forklifts.
Press Table Expansion: ROLLBLOC Loading Arms are designed for quick assembly, allowing them

to expand the press table horizontally. This feature accommodates different die sizes and configurations, providing flexibility in die-changing operations.
Quick and Safe Tool Transfer: The Loading Arms are designed to enable quick and efficient die changes. This helps reduce downtime and increase overall productivity.
Sturdy Construction: The company's consoles can withstand the heavy loads and harsh conditions of industrial environments. Sturdy construction ensures the longevity of the equipment.
Ease of Maintenance: Maintenance-friendly design with easily accessible components simplifies the upkeep of the cantilever consoles, ensuring they remain in optimal working condition. **SD**

LASER WELD MONITORING

IPG Photonics' LDD-700 Inline Welding Process Monitor

IPG's new monitoring systems are the next paradigm in industrial weld quality assurance. The LDD-700 weld monitoring system uses Inline Coherent Imaging (ICI) to provide a new level of detail and accuracy for laser weld monitoring. ICI uses a low-power IR

laser beam to gauge distances. This measurement beam is fired through the same optics as the welding laser, right to the

bottom of the keyhole, and records its depth in real time. The result is a direct, geometric measurement of weld penetration, acquired in-process. This data is comparable to a cut and etch of the entire length of the weld for every weld without destroying the part and the results are available instantly. On-board scanner mirrors allow the measurement beam to move independently of the welding beam, collecting additional data immediately ahead of and behind the melt pool on sub-ms time scales. A single LDD-700 can

monitor up to five different streams of welding data simultaneously, (and extract multiple metrics from each), replacing several previous-generation instruments and giving one unparalleled certainty in the quality of their products. The key features include • Multi-factor Monitoring that comprises Keyhole Depth, Workpiece Height, Seam Position, Finished Weld Profile, Transverse Weld Profile; Direct Weld Penetration; Active Process Control; Automatic PASS/FAIL; and Seamless Integration with IPG Beam Delivery. **SD**



IPG Photonics (India) Pvt Ltd
www.ipgphotonics.com
Hall & Stall: 4/B-110

Source: IPG Photonics (India) Pvt Ltd

DAVI

Heavy Duty Plate Rolls

MAV 3-roll with variable axis, mostly dedicated to the Oil & Gas sector

MCB 4-roll, with dedicated solutions and accessories for Wind Energy Towers and Foundations



www.davi.com



Batliboi Ltd.

Machine Tool Group

Bharat House, 5th Floor, 104 Bombay Samachar Marg, Fort, Mumbai – 400 001
T : +91.22.6637 8200 E : info@batliboi.com W : www.batliboi.com

OPTICAL MEASURING MACHINES

For Capturing Things Easily

ZEISS O-DETECT is an optical measuring machine that offers intuitive operation, high-quality imaging, and flexible lighting for precise measurements in an instant. The technology is suitable for a wide variety of components but excels with those that are best left untouched.

Key features

The machine provides a large field of view at high resolutions and offers

increased efficiency while capturing more details. Its calibration is in compliance with ISO 10360-7. It comes with intuitive and user-friendly ZEISS CALYPSO software. There are options of classic multi-segment blue and a white top light for general part top lighting. There is also a homogeneous dome light option for lighting

shiny workpieces. Darkfield-optimized lighting for challenging edges is to be incorporated soon. The inte-



Source: Carl Zeiss India (Bangalore) Pvt Ltd

Carl Zeiss India (Bangalore) Pvt Ltd
www.zeiss.co.in/metrology/home.html
Hall & Stall: 3A/A-122

grated 5 MP overview color camera locates the part quicker to start measurements. Since it is controlled by the software, there is less need to use the joystick. The dimensions of ZEISS O-DETECT 3/2/2 are 300 x 200 x 200 mm³. ZEISS O-DETECT 5/4/3 is also available with dimensions 500 x 400 x 300 mm³. The machine finds its applications in industries including Electronics, Casting, Industrial job shops, Stamping, Medical, and Automotive. **SD**

PCB CUTTING MACHINES

Chennai Metco's PCB Cutting Machine

One of the leading manufacturers of Metallography Equipment and its consumables, Chennai Metco has been a global player supplying machines and consumables related to metallography and petrography worldwide since its inception in 2000. The company offers a complete set-up for metallography and petrography lab ranging from sectioning,

mounting, grinding, polishing, hardness testing, and microscopy. Chennai Metco's range includes PCB saws designed for sectioning the PCBs utilized in electric vehicles. While PCBs are commonly used in automobiles, their usage is particularly prevalent in electric vehicles. Manufacturers across the board require precise sectioning of these PCBs.

The company presents a full line of PCB cutters, ranging from simple saws and route cutters to advanced diamond wire sectioning machines. Its offerings cater to the diverse needs of manufacturers seeking efficient solutions for PCB sectioning. Today, Chennai Metco proudly supplies PCB cutting machines to numerous Tier 1 vendors in the electric vehicle industry. **SD**



Source: Chennai Metco Pvt Ltd

Chennai Metco Pvt Ltd
www.chennai-metco.com
Hall & Stall: 3/C-116

INDUSTRY 4.0 SESSIONS @ IMTMA PRODUCTIVITY CENTRE

Sr.No	Sessions	Duration	Timing	Dates
1.	Introduction to Industry 4.0 & Smart Manufacturing Demo	1 Hour	11:00 - 12:00 am	January 20-23, 2024
	(Introduction to Industry 4.0 / OEE & Downtime Mgt. / CBM/EM/DMS)		3:00 - 4:00 pm	January 19-22, 2024
2.	Industrial Autonomous Robots - Presentation & Video Demo	30 Minutes	12:00 - 12:30 pm	January 20-23, 2024
3.	Immersive Technology in Industries - AR/VR/MR Demo	1 Hour	4:00 - 5:00 pm	January 19-22, 2024
4.	Augmented Reality in Web - Self Demo with Smart Phone	10 Minutes	Any Time	January 19-23, 2024
5.	Digital Readiness Check (DRC) - Self Assessment with Mobile or Tab	15 Minutes	Any Time	January 19-23, 2024

SMART MANUFACTURING SOLUTIONS

IcSoft ERP and MES

IcSoft's digital manufacturing solution seamlessly combines ERP, MES, and PLM, incorporating advanced technologies such as Digital Twin, IIOT, and no-code/low-code to provide a flexible, scalable, and intuitive system. Additionally, it features a built-in CRM and Vendor Portal to facilitate seamless Supply Chain Integration.

Headquartered in Bangalore, India, with presence in Europe, USA, and Pune, the company has been serving global customers for the past 24 years. **SD**

Intouch Systems Pvt Ltd
www.itspl.com
Hall & Stall: 5/C-123A

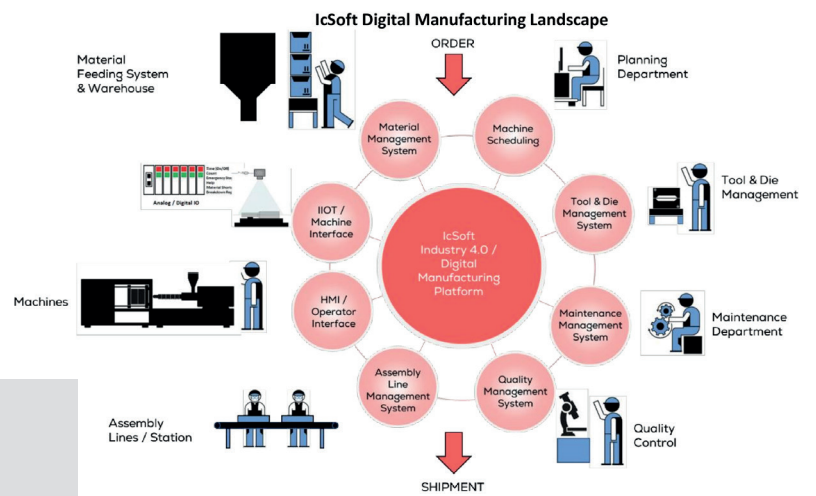

Source: Intouch Systems Pvt Ltd

LOAD MONITOR

Detecting the Load

The NEW SELBER RM-7404 VL Load Monitor has the function of detecting the press load with a strain gauge. It displays the accurate load during press processing and output stop signals and stops a press machine immediately when an abnormality is detected.

The monitor has the function of displaying the load value during press processing.

The load condition of the Die, Stamping Press Machine is very clear by confirming the load of the press process by waveform. Operation and maintenance is possible by grasping the load center, eccentricity load, etc.

Riken Keiki Nara Mfg. Co., Ltd
www.rikenkeikinara.co.jp/en/
Hall & Stall: 4/B-127B



Source: Riken Keiki Nara Mfg. Co., Ltd

LASER TUBE CUTTING

Revolutionizing Laser Tube Cutting

SLTL Group, a frontrunner in Industry 4.0 innovation, takes tube cutting to the next level with its revolutionary Laser Tube Cutting Series. This system flawlessly combines its proprietary laser technology with a robust, in-house-designed mechanical structure, setting a new benchmark for accuracy and productivity.

Precision Redefined: The T6150, T6200, and T6300 models introduce automation for complex tasks like bevel cutting, tube slitting, and automatic loading/unloading, reimagining the traditional process.

Advanced Software: Intuitive nesting programs allow one to create, modify, or delete programs on the fly, ensuring seamless integration into any manufacturing environment.

Expanded Versatility: One can handle a wide range of tube shapes effortlessly, including square, round, rectangular, angled, and many more, thanks to the perfect synergy of hardware and software.

Material Mastery: Designed for exceptional precision and quality, this system tackles materials like stainless steel, mild steel, aluminum, copper, brass, galvanized iron, and more with ease.

SLTL's Laser Tube Cutting Series, with its focus on the tube processing industry, delivers superior results and strengthens the Group's position as a leader in innovation. **SD**

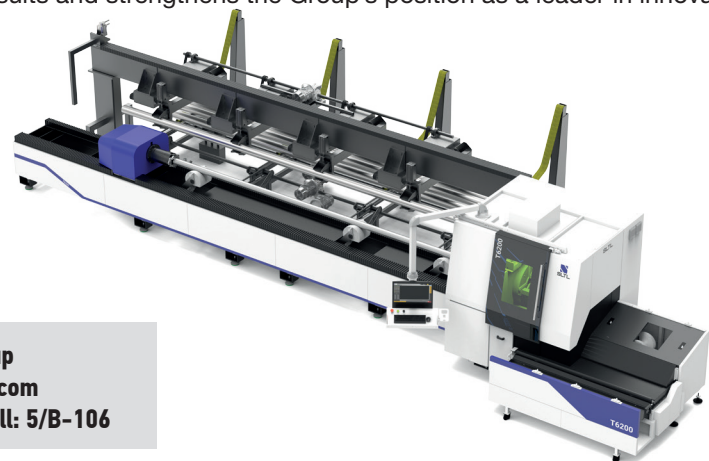

SLTL Group
www.sltl.com
Hall & Stall: 5/B-106

Source: SLTL Group

FIBER LASER CUTTING MACHINES

Laser Technologies' High-Power Fiber Laser Cutting Machines

High-power fiber laser cutting machines offer several benefits over traditional laser cutting machines, including:

- **Faster cutting speeds:** High-power lasers can cut through thicker materials at faster speeds than traditional lasers. This can lead to significant productivity gains, especially for manufacturers who need to produce large quantities of parts.
- **Improved accuracy and precision:** High-power lasers can produce more accurate and precise cuts than traditional

lasers. This is due to the fact that high-power lasers have a smaller beam diameter, which results in less heat-affected zone (HAZ). The HAZ is the area of material that is heated and weakened by the laser beam. A smaller HAZ means that the material is less likely to warp or distort during the cutting process, resulting in more accurate and precise parts.

- **Improved surface finish:** High-power lasers can produce a better surface finish than traditional lasers. This is because high power lasers can cut through materials with less heat, which

results in less dross (the molten material that is expelled from the cut). Less dross means that the surface finish of the part is smoother and more consistent.

- **Reduced operating costs:** High-power laser cutting machines can help to reduce operating costs in a number of ways. First, they can cut through thicker materials at faster speeds, which can lead to reduced labor costs. Second, they can produce more accurate and precise parts, which can reduce the need for post-processing. Third, they can produce a better surface finish, which can reduce

the need for painting or other finishing treatments.

Overall, high power fiber laser cutting machines offer several benefits that can help manufacturers to improve productivity, accuracy, and surface finish while reducing operating costs.

Here are some additional benefits of high-power fiber laser cutting machines:

- **Increased flexibility:** High-power lasers can cut a wider range of materials than traditional lasers. This includes metals, plastics, and composites.
- **Reduced environmental impact:** High-power lasers use less energy than traditional lasers. This can help to reduce the environmental impact of manufacturing operations.
- **Improved safety:** High-power lasers are less likely to cause eye injuries than traditional lasers. This is because they emit less infrared radiation.

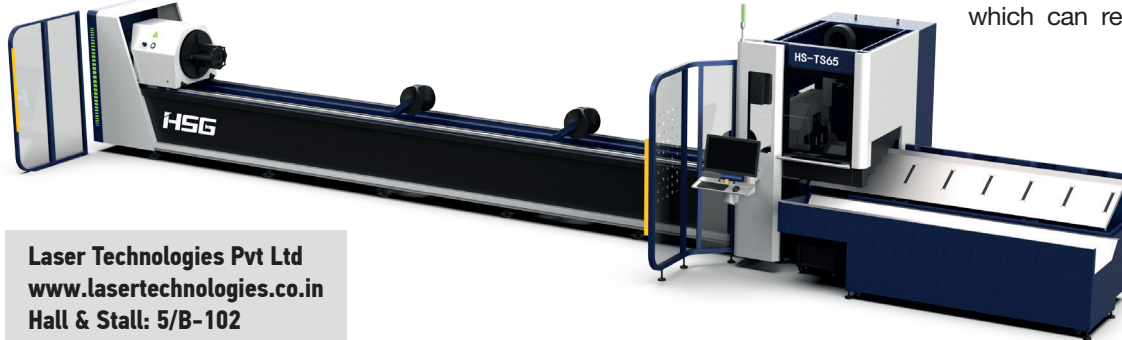

Laser Technologies Pvt Ltd
www.lasertechnologies.co.in
Hall & Stall: 5/B-102

Source: Laser Technologies Pvt Ltd

Kjellberg
INDIA

NEW

K 200

JUST CUTTING.

PLASMA CUTTING | 1 - 60 mm



Visit us at IMTEX
Hall 4, Stand B118



www.kjellberg.de

Revolutionizing sheet metal cutting by merging precision and efficiency

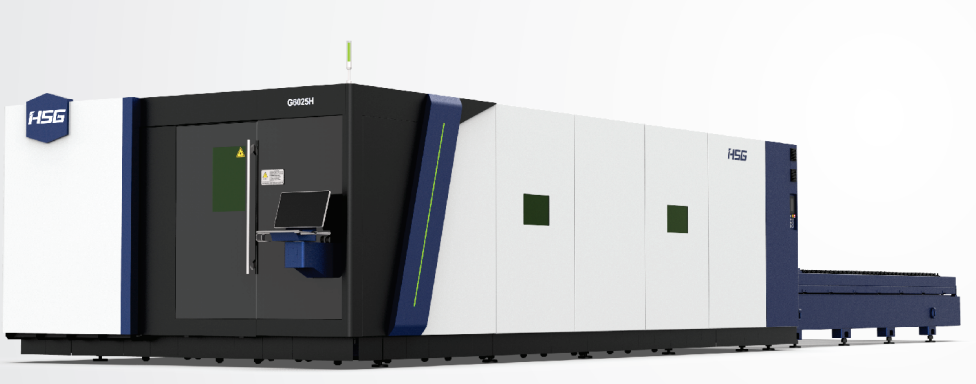

GH High-performance Fiber Laser Cutting Machine

- ▶ HSG BUS-based Control System.
- ▶ Follow-up Response Technology.
- ▶ Professional Nesting Software with Standard Configuration.
- ▶ Smart Factory and Standard Central Control System interface Intelligent Management.
- ▶ High-precision Transmission System
- ▶ Super Dynamic Performance for efficient processing maximum Linkage Speed can achieve 200m/min and the maximum Linkage Acceleration is 2.8 G, creating high-efficient sheet processing scene easily.

CUTTING SAMPLES



TUBE CUTTING MACHINE -TL660



- ▶ Variable Tube Handling: Cuts diverse diameters and lengths.
- ▶ Adaptable Laser Power: Offers power options for different cutting needs.
- ▶ Optimized Speed: Efficient cutting rates for faster production.
- ▶ CAD/CAM Integration: Seamlessly works with design software for precision.
- ▶ Heavy-duty pneumatic chucks for stable clamping.
- ▶ Maximum clamping diameter: 660mm (Round Tube).
- ▶ Single tube bearing: 3000 Kg.

CUTTING SAMPLES



IMTEX FORMING 2024 | 19-23 January 2024, Bangalore | **HALL NO. 5 STALL NO. B105**

Only The Best For You!



LASER TECHNOLOGIES PVT. LTD.

PAP/R/406, Rabale MIDC Rd,
Near DoI Electric Company,
Rabale, Navi Mumbai- 400701

Call: (+91) 86574 12551
Email: info@lasertechnologies.co.in
www.lasertechnologies.co.in

